

Giunti ad innesto rapido Serie 5000

Diametri nominali: 5, 7 mm - Filetti dei giunti: G1/8, G1/4, G3/8, G1/2
 Tubi di plastica: 6/4, 8/6, 10/8
 Tubi di gomma: 6x14, 8x17, 10x19, 13x23



I giunti ad innesto rapido della Serie 5000 sono ideali in situazioni dove, per ragioni impiantistiche o di sicurezza, è necessario connettere o disconnettere frequentemente i collegamenti di un impianto. Tale operazione viene effettuata senza dover scaricare la pressione, permettendo quindi un notevole risparmio di tempo.

I giunti ad Innesto rapido Serie 5000 con profilo Mini DN 5 sono compatibili con i giunti Rectus Serie 21 - 90, Legris 21. I giunti ad Innesto rapido Serie 5000 con profilo Europeo DN 7 sono compatibili con i giunti Cejn Serie 320.

CARATTERISTICHE GENERALI

| | |
|-------------------------|--|
| Gruppo valvola | rubinetto rapido automatico |
| Costruzione | a otturatore |
| Fissaggio | a mezzo filetto |
| Filettature | GAS cilindrico ISO 228 (BSP) |
| Materiali | OT nichelato (acciaio cementato e zincato solo per innesti con terza cifra 8 nel codice) guarnizioni NBR |
| Attacchi | G1/8 - G1/4 - G3/8 - G1/2 - per tubo plastica e tubo gomma |
| Temperatura d'esercizio | 0°C ÷ 80°C (con aria secca - 20°C) |
| Pressione d'esercizio | - 0,99 ÷ 12 bar |
| Pressione nominale | 6 bar |
| Portata nominale | vedi grafico |
| Diametro nominale | ø5 - ø7 |
| Fluido | aria compressa e altri fluidi a bassa pressione |

Giunti ad innesto rapido



Diagramma della portata

Il diagramma qui riportato serve per dare un'indicazione all'utilizzatore circa il modello da usare in rapporto alla pressione di lavoro ed alla portata necessaria. Le misurazioni sono state effettuate con i modelli seguenti indicati e sono la condizione ideale di massima portata. Qualora si debbano usare tubi inferiori, si dovrà tenere conto di un minor rendimento.

Q (NL/min) = portata
 Δp (bar) = variazione di pressione

P_a (bar) = pressione d'ingresso

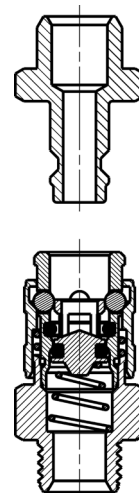
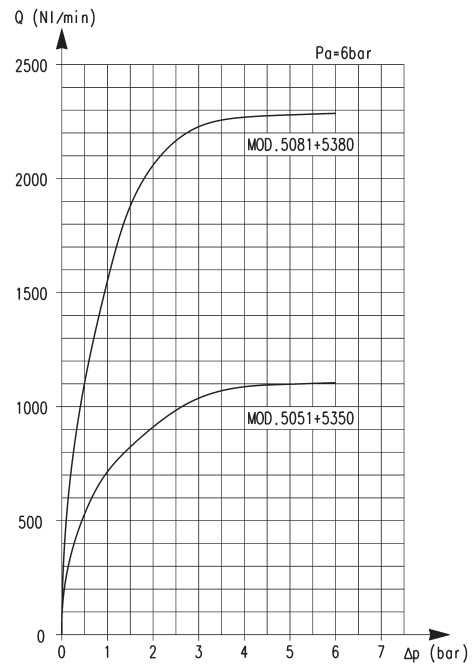

Raccordi Mod. 5051 Serie Mini e Mod. 5081 Standard Europeo



Giunto Maschio Cilindrico

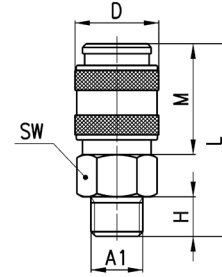

| DIMENSIONI | | | | | | | | |
|------------|------|---|----|----|------|------|----|----------|
| Mod. | A1 | ∅ | D | H | L | M | SW | Peso (g) |
| 5051 1/8 | G1/8 | 5 | 17 | 6 | 35 | 20,5 | 14 | 28 |
| 5051 1/4 | G1/4 | 5 | 17 | 8 | 37 | 20,5 | 17 | 37 |
| 5081 1/4 | G1/4 | 7 | 25 | 8 | 47,5 | 34,5 | 22 | 93 |
| 5081 3/8 | G3/8 | 7 | 25 | 9 | 48,5 | 34,5 | 22 | 92 |
| 5081 1/2 | G1/2 | 7 | 25 | 10 | 49,5 | 34,5 | 24 | 107 |



Raccordi Mod. 5052 Serie Mini e Mod. 5082 Standard Europeo



Giunto Maschio Passaparete Cilindrico

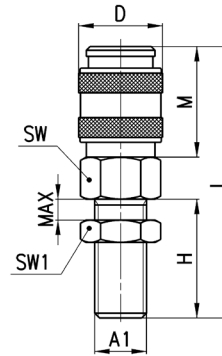

| DIMENSIONI | | | | | | | | | | |
|------------|------|---|----|----|------|------|-----|----|-----|----------|
| Mod. | A1 | ∅ | D | H | L | M | max | SW | SW1 | Peso (g) |
| 5052 1/8 | G1/8 | 5 | 17 | 23 | 52 | 20,5 | 12 | 14 | 14 | 38 |
| 5052 1/4 | G1/4 | 5 | 17 | 24 | 53 | 20,5 | 12 | 17 | 17 | 52 |
| 5082 1/4 | G1/4 | 7 | 25 | 24 | 63,5 | 34,5 | 12 | 22 | 17 | 103 |

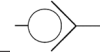

Raccordi Mod. 5053 Serie Mini e Mod. 5083 Standard Europeo



Giunto Femmina Cilindrico

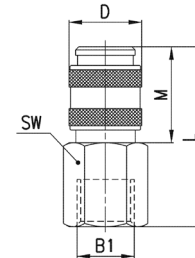

| DIMENSIONI | | | | | | | | |
|------------|------|---|----|------|------|----|----------|--|
| Mod. | B1 | ∅ | D | L | M | SW | Peso (g) | |
| 5053 1/8 | G1/8 | 5 | 17 | 37,5 | 20,5 | 14 | 33 | |
| 5053 1/4 | G1/4 | 5 | 17 | 39,5 | 20,5 | 17 | 44 | |
| 5083 1/4 | G1/4 | 7 | 25 | 47,5 | 34,5 | 17 | 88 | |
| 5083 3/8 | G3/8 | 7 | 25 | 49 | 34,5 | 20 | 93 | |
| 5083 1/2 | G1/2 | 7 | 25 | 53 | 34,5 | 24 | 103 | |



Raccordi Mod. 5054 Serie Mini e Mod. 5084 Standard Europeo



Giunto a Calzamento

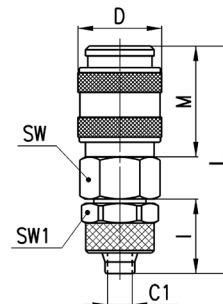

| DIMENSIONI | | | | | | | | | | |
|------------|------|---|-----|----|------|------|------|----|-----|----------|
| Mod. | Tubo | ∅ | C1 | D | I | L | M | SW | SW1 | Peso (g) |
| 5054 6/4 | 6/4 | 5 | 3 | 17 | 15 | 44 | 20,5 | 14 | 12 | 36 |
| 5054 8/6 | 8/6 | 5 | 5 | 17 | 15 | 44 | 20,5 | 14 | 14 | 38 |
| 5084 8/6 | 8/6 | 7 | 5 | 25 | 15 | 54,5 | 34,5 | 22 | 14 | 99 |
| 5084 10/8 | 10/8 | 7 | 6,5 | 25 | 16,5 | 56 | 34,5 | 22 | 16 | 103 |

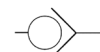

Raccordi Mod. 5055 Serie Mini



Giunto Passaparete a Calzamento

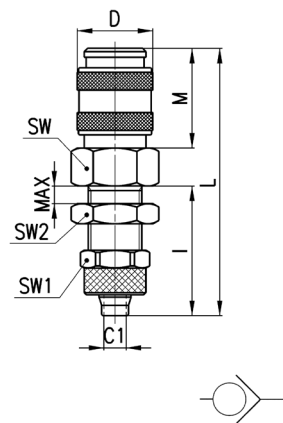

| DIMENSIONI | | | | | | | | | | | | |
|------------|------|---|----|----|----|----|------|-----|----|-----|-----|----------|
| Mod. | Tubo | ∅ | C1 | D | I | L | M | Max | SW | SW1 | SW2 | Peso (g) |
| 5055 6/4 | 6/4 | 5 | 3 | 17 | 29 | 58 | 20,5 | 10 | 14 | 12 | 14 | 44 |
| 5055 8/6 | 8/6 | 5 | 5 | 17 | 29 | 58 | 20,5 | 11 | 17 | 14 | 17 | 52 |

Raccordi Mod. 5056 Serie Mini e Mod. 5086 Standard Europeo



Giunto a Resca

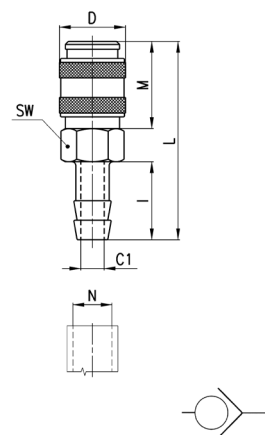

| DIMENSIONI | | | | | | | | | |
|------------|----|---|----|----|----|------|------|----|----------|
| Mod. | N | ∅ | C1 | D | I | L | M | SW | Peso (g) |
| 5056 06 | 6 | 5 | 3 | 17 | 20 | 49 | 20,5 | 14 | 30 |
| 5056 09 | 9 | 5 | 5 | 17 | 20 | 49 | 20,5 | 14 | 32 |
| 5086 09 | 9 | 7 | 5 | 25 | 20 | 59,5 | 34,5 | 22 | 95 |
| 5086 12 | 12 | 7 | 8 | 25 | 20 | 59,5 | 34,5 | 22 | 96 |

Raccordi Mod. 5057 Serie Mini e Mod. 5087 Standard Europeo



Giunto Portagomma

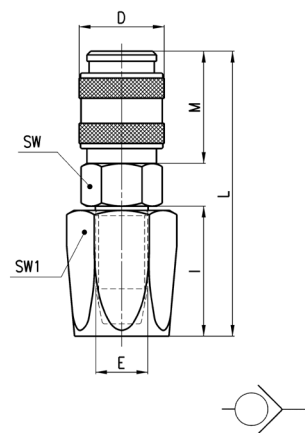

| DIMENSIONI | | | | | | | | | | |
|------------|---------|---|----|----|----|------|------|----|-----|----------|
| Mod. | Tubo | ∅ | E | D | I | L | M | SW | SW1 | Peso (g) |
| 5057 6x14 | 6 x 14 | 5 | 9 | 17 | 25 | 54,5 | 20,5 | 17 | 17 | 62 |
| 5087 6x14 | 6 x 14 | 7 | 9 | 25 | 25 | 64,5 | 34,5 | 22 | 17 | 117 |
| 5087 8x17 | 8 x 17 | 7 | 10 | 25 | 25 | 64,5 | 34,5 | 22 | 19 | 123 |
| 5087 10x19 | 10 x 19 | 7 | 12 | 25 | 27 | 66,5 | 34,5 | 22 | 22 | 141 |
| 5087 13x23 | 13 x 23 | 7 | 15 | 25 | 37 | 76,5 | 34,5 | 22 | 27 | 195 |

Raccordi Mod. 5058 Serie Mini e Mod. 5088 Standard Europeo



Giunto con Molla

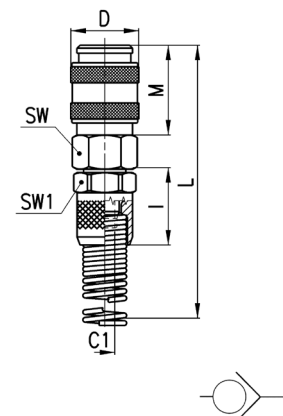

| DIMENSIONI | | | | | | | | | | |
|------------|------|---|-----|----|------|------|-------|----|-----|----------|
| Mod. | Tubo | ∅ | C1 | D | I | M | L | SW | SW1 | Peso (g) |
| 5058 6/4 | 6/4 | 5 | 3 | 17 | 19 | 20,5 | 120,5 | 14 | 14 | 48 |
| 5058 8/6 | 8/6 | 5 | 5 | 17 | 19 | 20,5 | 124,5 | 14 | 14 | 54 |
| 5088 8/6 | 8/6 | 7 | 5 | 25 | 19 | 34,5 | 135 | 22 | 14 | 118 |
| 5088 10/8 | 10/8 | 7 | 6,5 | 25 | 21,5 | 34,5 | 139,5 | 22 | 16 | 125 |

Raccordi Mod. 5150 Profilo Mini e Mod. 5180 Profilo Europeo



Innesto Maschio

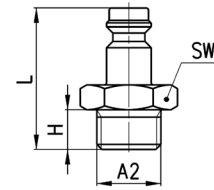

| DIMENSIONI | | | | | | |
|------------|------|---|----|------|----|----------|
| Mod. | A2 | ∅ | H | L | SW | Peso (g) |
| 5150 1/8 | G1/8 | 5 | 6 | 26 | 13 | 12 |
| 5150 1/4 | G1/4 | 5 | 8 | 28,5 | 17 | 19 |
| 5180 1/4 | G1/4 | 7 | 8 | 33 | 17 | 21 |
| 5180 3/8 | G3/8 | 7 | 9 | 34 | 19 | 26 |
| 5180 1/2 | G1/2 | 7 | 10 | 35,5 | 24 | 34 |

Raccordi Mod. 5350 Profilo Mini e Mod. 5380 Profilo Europeo



Innesto Femmina

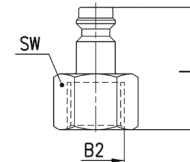

| DIMENSIONI | | | | | |
|------------|------|---|------|----|----------|
| Mod. | B2 | ∅ | L | SW | Peso (g) |
| 5350 1/8 | G1/8 | 5 | 25,5 | 13 | 14 |
| 5350 1/4 | G1/4 | 5 | 27,5 | 17 | 18 |
| 5380 1/4 | G1/4 | 7 | 31,5 | 17 | 21 |
| 5380 3/8 | G3/8 | 7 | 32,5 | 19 | 23 |
| 5380 1/2 | G1/2 | 7 | 36,5 | 24 | 37 |

Raccordi Mod. 5450 Profilo Mini e Mod. 5480 Profilo Europeo



Innesto a Calzamento

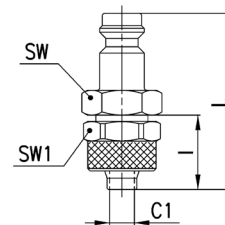

| DIMENSIONI | | | | | | | | |
|------------|------|---|-----|------|------|----|-----|----------|
| Mod. | Tubo | ∅ | C1 | I | L | SW | SW1 | Peso (g) |
| 5450 6/4 | 6/4 | 5 | 3 | 15 | 35 | 12 | 12 | 17 |
| 5450 8/6 | 8/6 | 5 | 5 | 15 | 35 | 13 | 14 | 22 |
| 5480 8/6 | 8/6 | 7 | 5 | 15 | 39,5 | 14 | 14 | 25 |
| 5480 10/8 | 10/8 | 7 | 6,5 | 16,5 | 41,5 | 17 | 16 | 33 |

Raccordi Mod. 5650 Profilo Mini e Mod. 5680 Profilo Europeo



Innesto a Calzamento

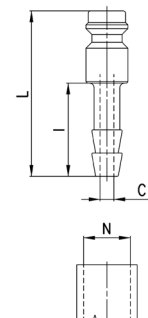

| DIMENSIONI | | | | | | |
|------------|----|---|----|----|------|----------|
| Mod. | N | ∅ | C1 | I | L | Peso (g) |
| 5650 06 | 6 | 5 | 3 | 20 | 35,5 | 8 |
| 5650 09 | 9 | 5 | 5 | 20 | 35,5 | 11 |
| 5680 06 | 6 | 7 | 3 | 20 | 40 | 14 |
| 5680 09 | 9 | 7 | 5 | 20 | 40 | 15 |
| 5680 12 | 12 | 7 | 7 | 20 | 40 | 19 |

Raccordi Mod. 5750 Profilo Mini e Mod. 5780 Profilo Europeo



Innesto Portagomma

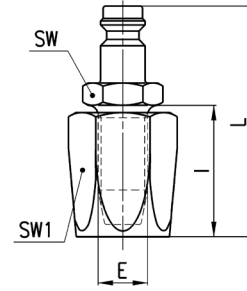

| DIMENSIONI | | | | | | | | |
|------------|---------|---|----|----|----|----|-----|----------|
| Mod. | Tubo | Ø | E | I | L | SW | SW1 | Peso (g) |
| 5750 6x14 | 6 X 14 | 5 | 9 | 25 | 45 | 14 | 17 | 40 |
| 5780 6x14 | 6 X 14 | 7 | 9 | 25 | 50 | 14 | 17 | 44 |
| 5780 8x17 | 8 X 17 | 7 | 10 | 25 | 50 | 14 | 19 | 50 |
| 5780 13x23 | 13 X 23 | 7 | 15 | 37 | 62 | 19 | 27 | 123 |

Raccordi Mod. 5850 Profilo Mini e Mod. 5880 Profilo Europeo



Innesto con Molla

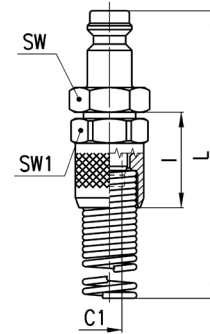

| DIMENSIONI | | | | | | | | |
|------------|------|---|-----|------|-------|----|-----|----------|
| Mod. | Tubo | Ø | C1 | I | L | SW | SW1 | Peso (g) |
| 5850 6/4 | 6/4 | 5 | 3 | 19 | 111,5 | 12 | 12 | 27 |
| 5850 8/6 | 8/6 | 5 | 5 | 19 | 116 | 14 | 14 | 40 |
| 5880 8/6 | 8/6 | 7 | 5 | 19 | 120 | 14 | 14 | 44 |
| 5880 10/8 | 10/8 | 7 | 6,5 | 21,5 | 125 | 17 | 16 | 55 |