

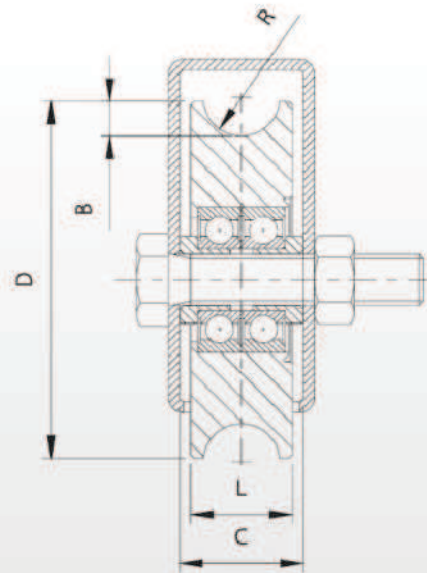







## Ruota gola semitonda a 2 cuscinetti

Wheel with half-rounded groove and 2 bearings  
Galet avec gorge demi-ronde et 2 roulements  
Schiebetrolle mit Rundrinne und 2 Kugellagern



Peso uniformemente distribuito - Equally distributed weight

315  semitonda													
Articolo	Codice		B	C	D	L	R	 287	 289		 Kg		 Kg
315-100	11505040 001	2	9,5	34	Ø 98	28	10,5	Ø 19	Ø 19	M14 x 70	425	8	10,80
315-120	11505050 001	2	9,5	34	Ø 117	28	10,5	Ø 19	Ø 19	M14 x 70	450	6	11,90
315-140	11505060 001	2	9,5	44	Ø 137	31	11,5	Ø 19	Ø 19	M16 x 70	550	2	6,20
315-160	11505070 001	2	9,5	44	Ø 157	33	11,5	Ø 19	Ø 19	M16 x 70	575	2	8,90
315-200	11505080 001	2	9,5	44	Ø 197	33	11,5	Ø 19	Ø 19	M16 x 70	625	2	14,40

