

MADE IN ITALY



ANI
PASSIONE STRAORDINARIA



INNESTI RAPIDI

**NEW
2019**

QUICK FITTINGS

EMBOUS RAPIDES

KUPPLUNGSSTECKER



INNESTI RAPIDI CON PROFILO INTERNAZIONALE | QUICK FITTINGS WITH INTERNATIONAL PROFILE
 RACCORDS RAPIDES AVEC PROFIL INTERNATIONAL | SCHNELLKUPPLUNGEN MIT INTERNATIONALEM PROFIL



14/A-14/B
15/A-15/B

14/A OMNI – 15/A OMNI
15/C OMNI

EUR/2 – EUR/3

SWE/1 – SWE/2

PROFILO STANDARD ITALIANO
ITALIAN PROFILE
PROFIL STANDARD ITALIEN
ITALIENISCHES STANDARDPROFIL

PROFILO STANDARD TEDESCO
GERMAN STANDARD PROFILE
PROFIL STANDARD ALLEMAND
DEUTSCHES STANDARDPROFIL

PROFILO STANDARD SVEDESE-AMERICANO
SWEDISH-AMERICAN STANDARD PROFILE
PROFIL STANDARD SUÉDOIS-AMÉRICAIN
SCHWEDISCH-AMERIKANISCHES STANDARDPROFIL

PROFILO A NORMA UNI ISO 6150B-12
PROFILE COMPLYING WITH THE UNI ISO
6150-12 STANDARD
PROFIL SELON LA NORME UNI ISO 6150B-12
PROFIL NACH DER NORM UNI ISO 6150-12



GRAFICO PORTATA ARIA | AIRFLOW DIAGRAM | GRAPHIQUE DEBIT AIR | DIAGRAMM DER FÖRDERMENGE



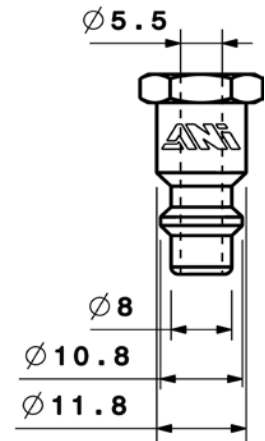
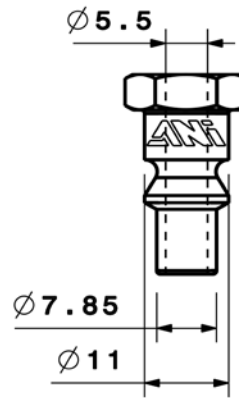
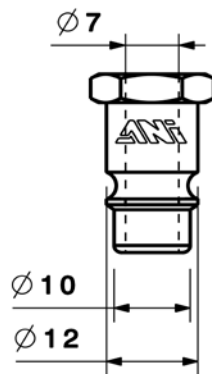
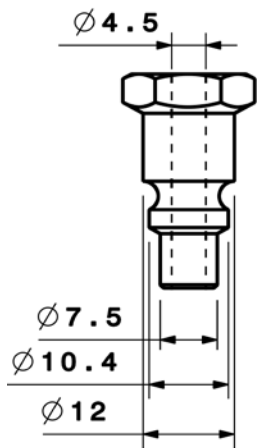
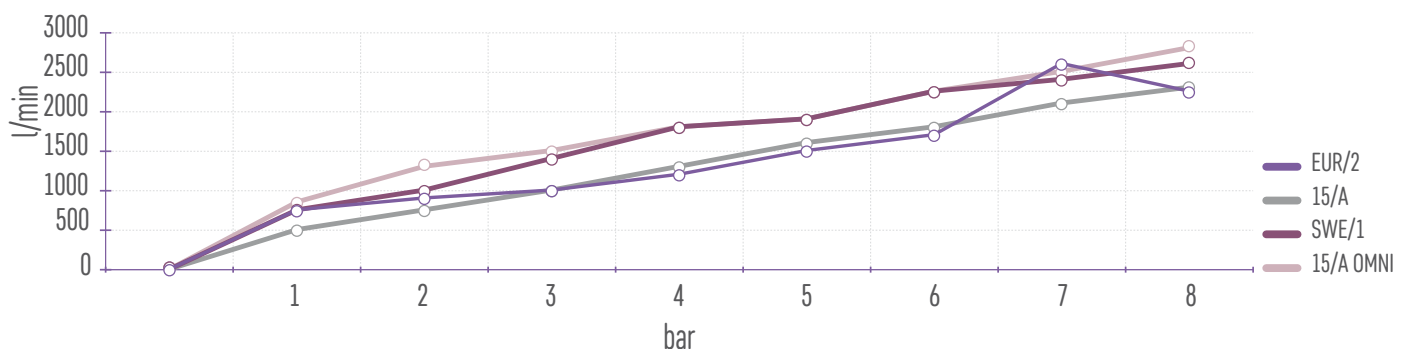

15/A

INNESTO RAPIDO PROFILO ITALIA FILETTATO MASCHIO | MALE THREADED ITALIAN PROFILE QUICK FITTING
 EMBOUT RAPIDE PROFIL ITALIEN FILETE MALE | KUPPLUNGSSTECKER ITALIENISCHES PROFIL MIT AUSSENGEWINDE

- Filettatura cilindrica ISO 228 (BSPP)
- Acciaio carbonitrurato e zincato
- Filetage cylindrique ISO 228 (BSPP)
- Acier carbonitruré et zingué
- Cylindrical Thread - ISO 228 (BSPP)
- Carbonitrided and zinc-plated steel
- Zylindrisches Gewinde ISO 228 (BSPP)
- Karbonitrierter und verzinkter Stahl

COD.	MOD.	F	P	L			
AS020201	15/A	1/8M	9	40	14	10	23
AS020202	15/A	1/4M	10	40	15	10	23
AS020203	15/A	3/8M	10	40	17	10	28

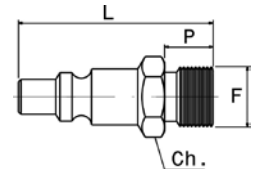

15/A

INNESTO RAPIDO PROFILO ITALIA FILETTATO FEMMINA | FEMALE THREADED ITALIAN PROFILE QUICK FITTING
 EMBOUT RAPIDE PROFIL ITALIEN FILETE FEMME | KUPPLUNGSSTECKER ITALIENISCHES PROFIL MIT INNENGEWINDE

- Filettatura cilindrica ISO 228 (BSPP)
- Acciaio carbonitrurato e zincato
- Filetage cylindrique ISO 228 (BSPP)
- Acier carbonitruré et zingué
- Cylindrical Thread - ISO 228 (BSPP)
- Carbonitrided and zinc-plated steel
- Zylindrisches Gewinde ISO 228 (BSPP)
- Karbonitrierter und verzinkter Stahl

COD.	MOD.	F	P	L			
AS020204	15/A	1/8F	10	39	14	10	23
AS020205	15/A	1/4F	10	40	16	10	23
AS020206	15/A	3/8F	10	40	19	10	26

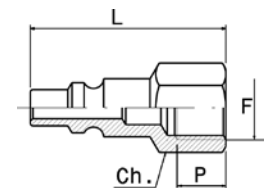

15/B

INNESTO RAPIDO PROFILO ITALIA CON BAIONETTA | ITALIAN PROFILE QUICK FITTING WITH BAYONET CONNECTOR
 EMBOUT RAPIDE PROFIL ITALIEN AVEC BAIJONNETTE | KUPPLUNGSSTECKER ITALIENISCHES PROFIL MIT BAJONETT

- Acciaio carbonitrurato e zincato
- Guarnizione in gomma NBR
- Acier carbonitruré et zingué
- Joint en caoutchouc NBR
- Carbonitrided and zinc-plated steel
- NBR rubber washers
- Karbonitrierter und verzinkter Stahl
- NBR-Dichtungen

COD.	MOD.	F	A	B	L		
AH020301	15/B	∅ 15.8	5	5,5	40	10	28
BB0180551	GUARNIZIONE WASHER 10/A-10/B					50	

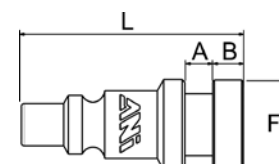



15/A OMNI

INNESTO RAPIDO PROFILO GERMANIA FILETTATO MASCHIO | MALE THREADED GERMAN PROFILE QUICK FITTING
EMBOUT RAPIDE PROFIL ITALIEN ALLEMAGNE FILETE MALE | KUPPLUNGSSTECKER DEUTSCHES PROFIL MIT AUSSENGEWINDE

- Maschio conico ISO 7 (BSPT) - DIN 2999 - BS 21
- Acciaio carbonitrurato e zincato
- COMPATIBILITÀ CEJN 320 - RECTUS 26 MILTON 760, 761, 762, 763
- Mâle conique ISO 7 (BSPT) - DIN 2999 - BS 21
- Acier carbonitruré et zingué
- COMPATIBILITE CEJN 320 - RECTUS 26 MILTON 760, 761, 762, 763
- Conical male thread ISO 7 (BSPT) - DIN 2999 - BS 21
- Carbonitrided and zinc-plated steel
- COMPATIBILITY CEJN 320 - RECTUS 26 MILTON 760, 761, 762, 763
- Konisches Außengewinde ISO 7 (BSPT) - DIN 2999 - BS 21
- Karbonitrierter und verzinkter Stahl
- KOMPATIBILITÄT CEJN 320 - RECTUS 26 MILTON 760, 761, 762, 763

COD.	MOD.	F	P	L			
AT023401	15/A OMNI	1/4M BSPT	10	35	14	10	19
AT023402	15/A OMNI	3/8M BSPT	12	38	17	10	24
AT023403	15/A OMNI	1/2M BSPT	14	41	22	10	38

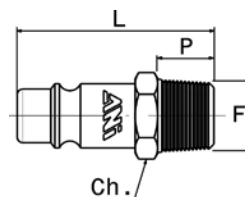

15/A OMNI

INNESTO RAPIDO PROFILO GERMANIA FILETTATO FEMMINA | FEMALE THREADED GERMAN PROFILE QUICK FITTING
EMBOUT RAPIDE PROFIL ITALIEN ALLEMAGNE FILETE FEMELLE | KUPPLUNGSSTECKER DEUTSCHES PROFIL MIT INNENGEWINDE

- Femmina cilindrica ISO 228 (BSPP)
- Acciaio carbonitrurato e zincato
- COMPATIBILITÀ CEJN 320 - RECTUS 26 MILTON 760, 761, 762, 763
- Femelle cylindrique ISO 228 (BSPP)
- Acier carbonitruré et zingué
- COMPATIBILITE CEJN 320 - RECTUS 26 MILTON 760, 761, 762, 763
- Cylindrical female thread - ISO 228 (BSPP)
- Carbonitrided and zinc-plated steel
- COMPATIBILITY CEJN 320 - RECTUS 26 MILTON 760, 761, 762, 763
- Zylindrisches Innengewinde ISO 228 (BSPP)
- Karbonitrierter und verzinkter Stahl
- KOMPATIBILITÄT CEJN 320 - RECTUS 26 MILTON 760, 761, 762, 763

COD.	MOD.	F	P	L			
AT023404	15/A OMNI	1/4 F	10	35	17	10	23
AT023405	15/A OMNI	3/8 F	12	38	19	10	24

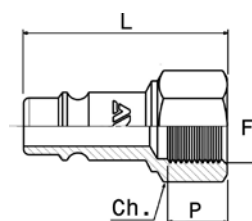

15/C OMNI

INNESTO RAPIDO PROFILO GERMANIA CON RESCA | GERMAN PROFILE QUICK FITTING WITH TAILPIECE
EMBOUT RAPIDE PROFIL ALLEMAGNE AVEC PORTE-TUYAU A EPI | KUPPLUNGSSTECKER DEUTSCHES PROFIL MIT SCHLAUCHTÜLLE

- Acciaio carbonitrurato e zincato
- COMPATIBILITÀ CEJN 320 - RECTUS 26
- Acier carbonitruré et zingué
- COMPATIBILITE CEJN 320 - RECTUS 26
- Carbonitrided and zinc-plated steel
- COMPATIBILITY CEJN 320 - RECTUS 26
- Karbonitrierter und verzinkter Stahl
- KOMPATIBILITÄT CEJN 320 - RECTUS 26

COD.	MOD.	F	P	L	f		
AT023801	15/C OMNI	ø 6	24	48	ø 3	10	14
AT023802	15/C OMNI	ø 8	24	48	ø 4.75	10	15
AT023804	15/C OMNI	ø 10	24	48	ø 6	10	18
AT023803	15/C OMNI	ø 13	24	48	ø 7	10	20

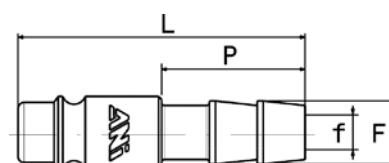



EUR/2

INNESTO RAPIDO PROFILO AMERICANO E SVEDESE FILETTATO MASCHIO | MALE THREADED SWEDISH-AMERICAN PROFILE QUICK FITTING
EMBOUT RAPIDE PROFIL AMERICAIN ET SUEDOIS FILETE MALE | KUPPLUNGSSTECKER SWEDISCH-AMERIKANISCHES PROFIL MIT AUSSENGEWINDE

- Maschio conico ISO 7 (BSPT) -DIN 2999 - BS 21
- Acciaio carbonitrurato e zincato
- COMPATIBILITÀ ARO 210 - PARKER 50 - CEJN 300 ORION 44510 - RECTUS 22
- *Conical male thread ISO 7 (BSPT) - DIN 2999 - BS 21*
- *Carbonitrided and zinc-plated steel*
- *COMPATIBILITY ARO 210 - PARKER 50 - CEJN 300 ORION 44510 - RECTUS 22*
- *Mâle conique ISO 7 (BSPT) -DIN 2999 - BS 21*
- *Acier carbonitruré et zingué*
- *COMPATIBILITE ARO 210 - PARKER 50 - CEJN 300 ORION 44510 - RECTUS 22*
- *Konisches Außengewinde ISO 7 (BSPT) - DIN 2999 - BS 21.*
- *Karbonitrierter und verzinkter Stahl*
- *KOMPATIBILITÄT ARO 210 - PARKER 50 - CEJN 300 ORION 44510 - RECTUS 22*

COD.	MOD.	F	P	L			
AT022802	EUR/2	1/4M BSPT	11	39	14	10	20
AT022803	EUR/2	3/8M BSPT	10	39	18	10	29

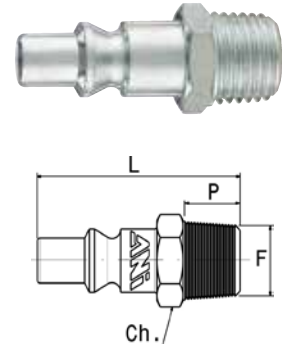

EUR/2

INNESTO RAPIDO PROFILO AMERICANO E SVEDESE FILETTATO FEMMINA | FEMALE THREADED SWEDISH-AMERICAN PROFILE QUICK FITTING
EMBOUT RAPIDE PROFIL AMERICAIN ET SUEDOIS FILETE FEMELLE | KUPPLUNGSSTECKER SWEDISCH-AMERIKANISCHES PROFIL MIT INNENGEWINDE

- Femmina cilindrica ISO 228 (BSPP)
- Acciaio carbonitrurato e zincato
- COMPATIBILITÀ ARO 210 - PARKER 50 - CEJN 300 ORION 44510 - RECTUS 22
- *Cylindrical female thread - ISO 228 (BSPP)*
- *Carbonitrided and zinc-plated steel*
- *COMPATIBILITY ARO 210 - PARKER 50 - CEJN 300 ORION 44510 - RECTUS 22*
- *Femelle cylindrique ISO 228 (BSPP)*
- *Acier carbonitruré et zingué*
- *COMPATIBILITE ARO 210 - PARKER 50 - CEJN 300 ORION 44510 - RECTUS 22*
- *Zylindrisches Innengewinde ISO 228 (BSPP).*
- *Karbonitrierter und verzinkter Stahl*
- *KOMPATIBILITÄT ARO 210 - PARKER 50 - CEJN 300 ORION 44510 - RECTUS 22*

COD.	MOD.	F	P	L			
AT022805	EUR/2	1/4F	9,5	37	18	10	21
AT022806	EUR/2	3/8F	9,5	37	18	10	23

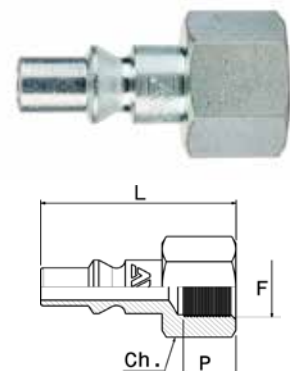

EUR/3

INNESTO RAPIDO PROFILO AMERICANO E SVEDESE CON RESCA | SWEDISH AND AMERICAN PROFILE QUICK FITTING WITH TAILPIECE
EMBOUT RAPIDE PROFIL AMERICAIN ET SUEDOIS AVEC PORTE-TUYAU A EPI | KUPPLUNGSSTECKER SWEDISCHES UND AMERIKANISCHES PROFIL MIT SCHLAUCHTÜLLE

- Acciaio carbonitrurato e zincato
- COMPATIBILITÀ ARO 210 - PARKER 50 CEJN 300 - ORION 44510 - RECTUS 22
- *Carbonitrided and zinc-plated steel*
- *COMPATIBILITY ARO 210 - PARKER 50 CEJN 300 - ORION 44510 - RECTUS 22*
- *Acier carbonitruré et zingué*
- *COMPATIBILITE ARO 210 - PARKER 50 CEJN 300 - ORION 44510 - RECTUS 22*
- *Karbonitrierter und verzinkter Stahl*
- *KOMPATIBILITÄT ARO 210 - PARKER 50 CEJN 300 - ORION 44510 - RECTUS 22*

COD.	MOD.	F	P	L	f		
AT022901	EUR/3	ø 6	24	51	ø 3	10	14
AT022902	EUR/3	ø 8	24	51	ø 4.75	10	16
AT022903	EUR/3	ø 10	24	51	ø 5.5	10	20
AT022904	EUR/3	ø 13	24	51	ø 5.5	10	93

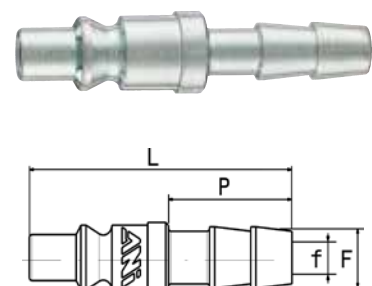



SWE/1

INNESTO RAPIDO PROFILO ISO 6150B-12 FILETTATO MASCHIO | MALE/ THREADED ISO 6150B-12 PROFILE QUICK FITTING
EMBOUT RAPIDE PROFIL ISO 6150B-12 FILETE MALE | KUPPLUNGSSTECKER ISO 6150B-12 PROFIL MIT AUSSENGEWINDE

- Maschio conico ISO 7 (BSPT) -DIN 2999 - BS 21
- Acciaio carbonitrurato e zincato
- COMPATIBILITÀ US-MIL-SPEC-C-4109 - CEJN
HANSEN 3000 - GROMELLE 600 - PARKER 30 1/4
RECTUS 24
- Mâle conique ISO 7 (BSPT) -DIN 2999 - BS 21
- Acier carbonitruré et zingué
- COMPATIBILITE US-MIL-SPEC-C-4109 - CEJN
HANSEN 3000 - GROMELLE 600 - PARKER 30 1/4
RECTUS 24
- Conical male thread ISO 7 (BSPT) - DIN 2999 - BS 21
- Carbonitrided and zinc-plated steel
- COMPATIBILITY US-MIL-SPEC-C-4109 - CEJN
HANSEN 3000 - GROMELLE 600 - PARKER 30 1/4
RECTUS 24
- Konisches Außengewinde ISO 7 (BSPT) - DIN 2999 - BS 21
- Karbonitrierter und verzinkter Stahl
- KOMPATIBILITÄT US-MIL-SPEC-C-4109 - CEJN
HANSEN 3000 - GROMELLE 600 - PARKER 30 1/4
RECTUS 24

COD.	MOD.	F	P	L			
AT023901	SWE/1	1/4M	10	38	14	10	22
AT023902	SWE/1	3/8M	12	41	17	10	26

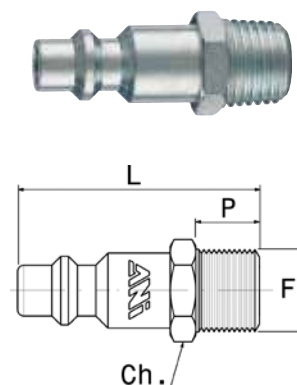

SWE/1

INNESTO RAPIDO PROFILO ISO 6150B-12 FILETTATO FEMMINA | FEMALE THREADED ISO 6150B-12 PROFILE QUICK FITTING
EMBOUT RAPIDE PROFIL ISO 6150B-12 FILETE FEMELLE | KUPPLUNGSSTECKER ISO 6150B-12 PROFIL MIT INNENGEWINDE

- Femmina cilindrica ISO 228 (BSPP)
- Acciaio carbonitrurato e zincato
- COMPATIBILITÀ US-MIL-SPEC-C-4109 - CEJN
HANSEN 3000 - GROMELLE 600 - PARKER 30 1/4
RECTUS 24
- Femelle cylindrique ISO 228 (BSPP)
- Acier carbonitruré et zingué
- COMPATIBILITE US-MIL-SPEC-C-4109 - CEJN
HANSEN 3000 - GROMELLE 600 - PARKER 30 1/4
RECTUS 24
- Cylindrical female thread - ISO 228 (BSPP)
- Carbonitrided and zinc-plated steel
- COMPATIBILITY US-MIL-SPEC-C-4109 - CEJN
HANSEN 3000 - GROMELLE 600 - PARKER 30 1/4
RECTUS 24
- Zylindrisches Innengewinde ISO 228 (BSPP)
- Karbonitrierter und verzinkter Stahl
- KOMPATIBILITÄT US-MIL-SPEC-C-4109 - CEJN
HANSEN 3000 - GROMELLE 600 - PARKER 30 1/4
RECTUS 24

COD.	MOD.	F	P	L			
AT023904	SWE/1	1/4 F	10	38	17	10	25
AT023905	SWE/1	3/8 F	12	41	19	10	26

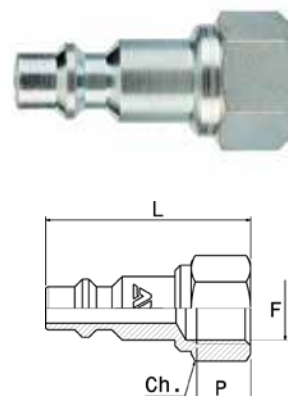

SWE/2

INNESTO RAPIDO PROFILO UNI ISO 6150B-12 CON RESCA | UNI ISO 6150B-12 PROFILE QUICK FITTING WITH TAILPIECE
EMBOUT RAPIDE PROFIL UNI ISO 6150B-12 AVEC PORTE-TUYAU A EPI | KUPPLUNGSSTECKER UNI ISO 6150B-12 PROFIL MIT SCHLAUCHTÜLLE

- Acciaio carbonitrurato e zincato
- COMPATIBILITÀ US-MIL-SPEC-C-4109 - CEJN -
HANSEN 3000 - GROMELLE 600 - PARKER 30 1/4
RECTUS 24
- Acier carbonitruré et zingué
- COMPATIBILITE US-MIL-SPEC-C-4109 - CEJN -
HANSEN 3000 - GROMELLE 600 - PARKER 30 1/4
RECTUS 24
- Carbonitrided and zinc-plated steel
- COMPATIBILITY US-MIL-SPEC-C-4109 - CEJN -
HANSEN 3000 - GROMELLE 600 - PARKER 30 1/4
RECTUS 24
- Karbonitrierter und verzinkter Stahl
- KOMPATIBILITÄT US-MIL-SPEC-C-4109 - CEJN -
HANSEN 3000 - GROMELLE 600 - PARKER 30 1/4
RECTUS 24

COD.	MOD.	F	P	L	f		
AT024001	SWE/2	ø 6	24	48	ø 3	10	14
AT024002	SWE/2	ø 8	24	48	ø 4.75	10	15
AT024003	SWE/2	ø 10	24	48	ø 5.5	10	19

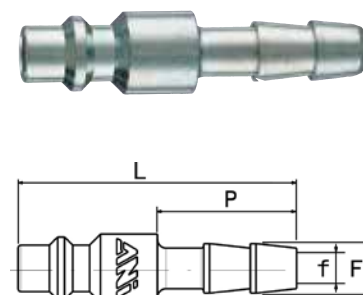



14/A | 14/B

INNESTO RAPIDO PROFILO ITALIA CON MASCHERINA PORTAGOMMA | ITALIAN PROFILE QUICK FITTING WITH SLEEVE FOR RUBBER HOSE
 EMBOUT RAPIDE PROFIL ITALIE AVEC MANCHON PORTE-TUYAU | KUPPLUNGSSTECKER ITALIENISCHES PROFIL MIT GUMMISCHLAUCHHALTEVERKLEIDUNG

- Innesso con mascherina portagomma
- Ottone nichelato
- Raccord avec manchon porte-tuyau
- Laiton nickelé
- Fitting with sleeve for rubber hose
- Nickel-plated brass
- Kupplung mit Gummischlauchhalteverkleidung
- Vernickeltes Messing

COD.	MOD.	Di X De	f	P	L	🔧1	🔧2	📄	🛒
AH020102	14/A	∅ 6 x 13	∅ 4	30	61	14	17	10	46
AH020103	14/A	∅ 6 x 14	∅ 4	30	61	14	19	10	45
AH020104	14/A	∅ 6 x 15	∅ 4	30	61	14	21	10	45
AH020105	14/A	∅ 6 x 16	∅ 4	30	61	14	21	10	50
AH020106	14/B	∅ 7 x 16	∅ 4.5	30	61	14	21	10	51
AH020110	14/B	∅ 8 x 12	∅ 4.5	29	61	17	17	10	49
AH020114	14/B	∅ 8 x 14	∅ 4.5	30	61	17	19	10	47
AH020113	14/B	∅ 8 x 15	∅ 4.5	30	61	14	21	10	49
AH020107	14/B	∅ 8 x 17	∅ 4.5	30	61	14	21	10	50
AH020108	14/B	∅ 10 x 17	∅ 4.5	31	61	14	20	10	59
AH020109	14/B	∅ 10 x 19	∅ 4.5	31	61	14	24	10	70

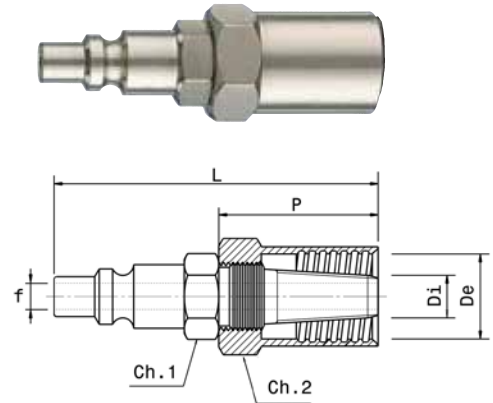

14/A OMNI

INNESTO RAPIDO PROFILO GERMANIA CON MASCHERINA PORTAGOMMA | GERMAN PROFILE QUICK FITTING WITH SLEEVE FOR RUBBER HOSE
 EMBOUT RAPIDE PROFIL ALLEMAGNE AVEC MANCHON PORTE-TUYAU | KUPPLUNGSSTECKER DEUTSCHES PROFIL MIT GUMMISCHLAUCHHALTEVERKLEIDUNG

- Ottone nichelato
- COMPATIBILITÀ CEJN 320 - RECTUS 26
- Laiton nickelé
- COMPATIBILITE CEJN 320 - RECTUS 26
- Nickel-plated brass (UNI EN 12164 CW 614N)
- COMPATIBILITY CEJN 320 - RECTUS 26
- Vernickeltes Messing (UNI EN 12164 CW 614N)
- KOMPATIBILITÄT CEJN 320 - RECTUS 26

COD.	MOD.	Di X De	f	P	L	🔧1	🔧2	📄	🛒
AH023504	14/A OMNI	∅ 8 x 12	∅ 5	30	56.5	14	17	10	50
AH023505	14/A OMNI	∅ 8 x 14	∅ 5	30	56.5	14	19	10	50
AH023501	14/A OMNI	∅ 8 x 17	∅ 5	30	56.5	14	21	10	55
AH023502	14/A OMNI	∅ 10 x 17	∅ 6	30	56.5	14	20	10	54
AH023503	14/A OMNI	∅ 10 x 19	∅ 6	30	56.5	14	24	10	68

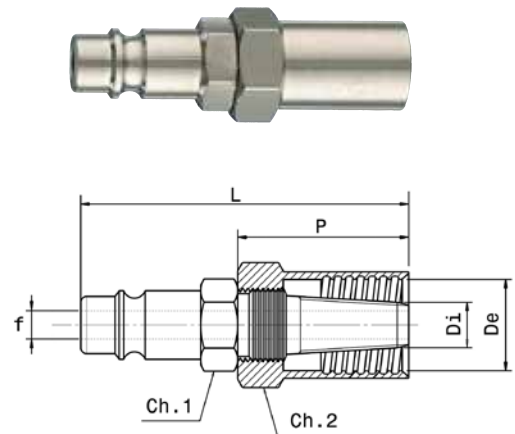



ANI SPA
Via Arzignano, 190
36072 CHIAMPO (VI) ITALY
tel. +39 0444 420888
fax +39 0444 420620
ani@ani.it

www.ani.it